

**PROlite** LED Lighting™

A Division of Emergensee® Lighting, Inc.

TYPE: \_\_\_\_\_ DATE: \_\_\_\_\_

JOB NAME: \_\_\_\_\_

CONTRACTOR: \_\_\_\_\_

CATALOG NO: \_\_\_\_\_

NOTES: \_\_\_\_\_

# PLEDMPALPRO15

15 Watt, Premium Multi-Purpose LED Area Luminaire

## FEATURES

- Available in 3000k (warm white), 4000k (neutral white) and 5000k (cool white) color temperatures.\*
- Long-life LEDs provide 372,000 hours of operation with at least 70% of initial lumen output (L70).\*\*
- PLEDMPALPRO15 provides 1,593 lumens (114 lumens per watt, LPW) at 3000k; 1,603 lumens (115 LPW) at 4000k; and 1,624 lumens (116 LPW) at 5000k.\*
- Standard optic provides an IES roadway type V distribution, or a 7V (vertical) x 7H (horizontal) NEMA floodlight distribution.
- Universal 120-277 AC voltage (50-60Hz) is standard.
- Power factor > 0.90.
- Total harmonic distortion < 20%.
- Color rendering index > 80.
- Optional glare shields (full & half) & wire guards are available.
- Die cast aluminum housing with durable, dark bronze powder coat finish—at least 2 mils thick on all surfaces—and a heat-resistant polycarbonate lens.
- Wireway enclosure is sealed with a water-tight, silicon rubber gasket.
- Effective projected areas (EPA's) are:
  - Front = 0.05 s.f. (knuckle) / 0.06 s.f. (yoke)
  - Side = 0.07 s.f. (knuckle & yoke)
  - Face = 0.20 s.f. (knuckle) / 0.23 s.f. (yoke)
- Easy installation in new construction or retrofit applications.

\* Contact factory for other color temperatures and lumen packages.  
\*\* L70 hours are IES TM-21-11 calculated hours.

## WARRANTY & LISTINGS

- cULus listed for wet locations in ambient temperatures from -20°C to 45°C (-4°F to 113°F).
- IP66 rated for ingress protection.
- DLC premium approved.
- Rated for 3G vibration.
- Lens is IK 8 rated for protection from external impacts.
- Salt fog tested for 1,000 hours (ASTM B117). After salt fog testing, paint rated at 9 per ASTM D1654-05 scratch test.
- Complies with FCC Part 15, class B.
- Complies with EN61000-4-5, surge immunity protection (2.5kV).
- 5-year warranty of all electronics and housing.



The PLEDMPALPRO series is a group of premium architectural LED area luminaires designed to illuminate parking areas, pathways, building facades, loading docks, and a wide variety of other large, general site lighting applications. Multiple mounting options make the LEDMPAL a versatile luminaire for flood lighting, pole-, ground- and wall-mounted area lighting, and other outdoor lighting requirements.

## MOUNTING OPTIONS

- Aluminum die-cast knuckle-mount option is installed on a junction box. Includes 1/2" NPS stem with locking nut.
- Yoke-mount option provides secure attachment to flat surfaces.

## DIMENSIONS

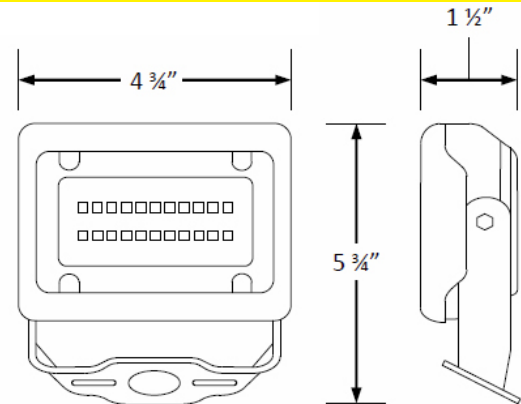

Weight: 0.9 lb. (knuckle) / 1.1 lb. (yoke)

## ORDERING INFORMATION: Example: PLEDMPALPRO15-3K + MPALPRO15-FGS + MPALPRO15-WG

MODEL	LUMINAIRE LUMENS	LUMINAIRE WATTS	LUMENS/WATT	COLOR TEMP	SHIELDS & WIREGUARDS
PLEDPALPRO15-3K	1,593	14	114	3K = 3000K	MPALPRO15-FGS=Full Glare Shield, 15W MPALPRO15-HGS=Half Glare Shield, 15W MPALPRO15-WG=Wire Guard, 15W
PLEDPALPRO15-4K	1,603	14	115	4K = 4000k	
PLEDPALPRO15-5K	1,624	14	116	5K = 5000k	

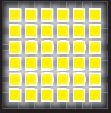

**PROlite LED Lighting™**

A Division of Emergensee® Lighting, Inc.

TYPE: \_\_\_\_\_ DATE: \_\_\_\_\_

JOB NAME: \_\_\_\_\_

CONTRACTOR: \_\_\_\_\_

CATALOG NO: \_\_\_\_\_

NOTES: \_\_\_\_\_

**ELECTRICAL**

MODEL	COLOR TEMP	CRI <sup>1</sup>	LUMINAIRE LUMENS	LUMINAIRE WATTS	LUMENS/WATT	INPUT VOLTAGE <sup>2</sup>	INPUT CURRENT (A)			POWER FACTOR	THD <sup>3</sup>	L <sub>70</sub> HOURS <sup>4</sup>
							120V	240V	277V			
PLEDPALPRO15-3K	3000k	> 80	1,593	14	114	120-277	0.12	0.06	0.05	> 90%	< 20%	372,000
PLEDPALPRO15-4K	4000k	> 80	1,603	14	115	120-277	0.12	0.06	0.05	> 90%	< 20%	372,000
PLEDPALPRO15-5K	5000k	> 80	1,624	14	116	120-277	0.12	0.06	0.05	> 90%	< 20%	372,000

<sup>1</sup> Color rendering index

<sup>2</sup> Total harmonic distortion

<sup>3</sup> Total harmonic distortion

<sup>4</sup> L<sub>70</sub> refers to the number of hours at which lumen output declines to 70% of the initial level. L<sub>70</sub> hours are IES TM-21-11 calculated hours.

**PHOTOMETRIC DATA**

(1,593 Lumens, Type V Distribution)

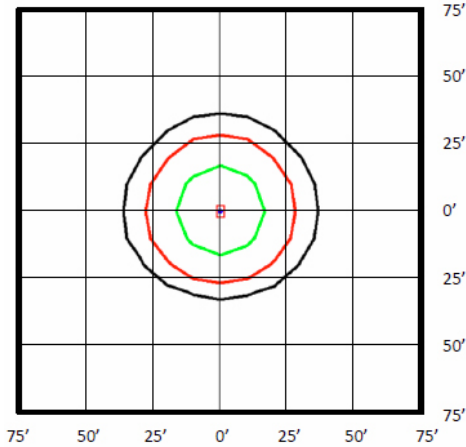

Foot Candles

- 5.0
- 2.0
- 1.0
- 0.5
- 0.2
- 0.1

Luminaire Orientation:

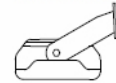

Notes:

- Isofootcandle plots depict initial footcandles at grade.
- Gridlines represent units of mounting height of 25 feet.

BUG Rating: B1-U0-G0

Zone	Lumens	%
FL - Front - Low (0-30)	237	15%
FM - Front - Medium (30-60)	426	27%
FH - Front - High (60-80)	97	6%
FVH - Front - Very High (80-90)	3	0%
<b>Total Forward Light</b>	<b>763</b>	<b>48%</b>
BL - Back - Low (0-30)	240	15%
BM - Back - Medium (30-60)	464	29%
BH - Back - High (60-80)	121	8%
BVH - Back - Very High (80-90)	5	0%
<b>Total Back Light</b>	<b>830</b>	<b>52%</b>
UL - Up Light - Low (90-100)	0	0%
UH - Up Light - High (100-180)	0	0%
<b>Total Up Light</b>	<b>0</b>	<b>0%</b>
<b>Total Lumens</b>	<b>1,593</b>	<b>100%</b>

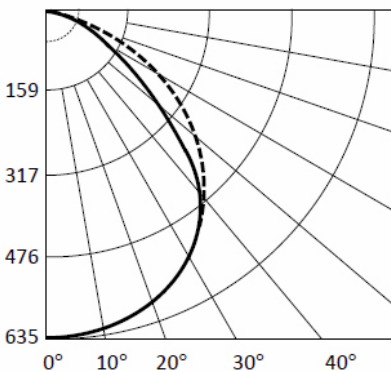

NEMA Floodlight Type Data

- Field Angles:
- Horizontal 152°
  - Vertical 142°

- NEMA Type:
- Horizontal 7H
  - Vertical 7V

Luminaire Orientation:



Maximum Candela = 635

- Horizontal
- - - Vertical

Shields

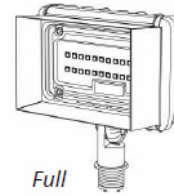

Full

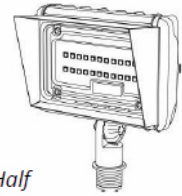

Half

Wire Guards

