



PROlite LED Lighting™

A Division of Emergensee® Lighting, Inc.

TYPE: _____ DATE: _____

JOB NAME: _____

CONTRACTOR: _____

CATALOG NO: _____

NOTES: _____

PLEDPNL1X4-40W

40 Watt 1x4 Ultra-Thin Edge-Lit LED Panel

FEATURES

- Available in 3000k (warm white), 3500k (warm/neutral white) 4000k (neutral white) & 5000k (cool white) color temperatures.*
- Long-life LEDs provide 56,000 hours of operation with at least 70% of initial lumen output (L70).**
- Provides 4,070 luminaire lumens (102 lumens per watt, LPW) at 3000k, 4,149 luminaire lumens (104 LPW) at both 3500k & 4000k, and 4,600 luminaire lumens (115 LPW) at 5000k.*
- Uniform illumination with no visible LED pixilation
- Universal 120-277 AC voltage (50-60Hz) is standard
- 0-10vdc dimming capability is standard
- Power factor > 0.90
- Total harmonic distortion < 20%
- Color rendering index > 80
- Aluminum housing
- PMMA (polymethyl methacrylate) acrylic lens with light guide panels for optimal light distribution and efficiency.
- Suitable for ambient temperatures from -25°C to 45°C (-13°F to 113°F).
- Easy installation in new construction or retrofit.
- Standard mounting options include recessed mounting in grid ceilings, or suspended mounting using attached hanging brackets. Optional surface mounting requires a surface mounting kit (option SMK)

*Contact factory for other color temperatures and lumen packages

**L₇₀ hours are IES TM-21-11 calculated hours



The ultra-thin, edge-lit LED panel (PLEDPNL) series is designed to deliver general ambient lighting in a variety of indoor settings, including schools, offices, hospitals and stores, and is the perfect choice for both new construction and retrofits. This high-efficacy luminaire provides long-life and uniform illumination, as well as standard 0-10 vdc dimming capability.

MOUNTING OPTIONS

- Optional Surface Mount Kits (LEDSMKT-14) and Flange Mounting Kits (FLANGEKIT14-ET) provide for installation on plaster or other hard ceilings.
- Optional Cable Mounting Kits (LEDPNL-CMK) provide additional security, as well as suspended mounting.

WARRANTY & LISTINGS

- ETL listed to applicable U.L. standards for damp locations and insulated ceilings (IC-rated). Suitable for ambient temperatures from -25°C to 45°C (-13°F to 113°F).
- DLC standard approved.
- Complies with RoHS (Restriction on Hazardous Substances) requirements.
- Complies with FCC Part 15.
- 5-year warranty of all electronics and housing.



DIMENSIONS

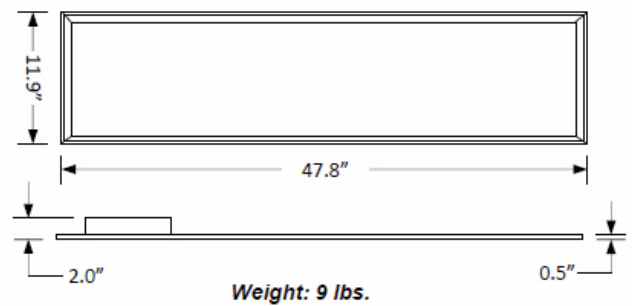

ORDERING INFORMATION: EXAMPLE: P LEDPNL1x4-40W-3K + LEDSMKT-14 + LEDPNL-CMK

MODEL	LUMINAIRE WATTS	LUMINAIRE LUMENS	LUMENS/WATT	COLOR TEMP	Options (Order Separately)
PPNL1X4-40W-3K	40	4,070	102	3K= 3000k	LEDSMKT-14=Surface Mounting Kit (1x4)
PPNL1X4-40W-35K	40	4,149	104	35K= 3500K	FLANGEKIT14-ET=Flange Mounting Kit (1x4)
PPNL1X4-40W-4K	40	4,149	104	4K= 4000k	LEDPNL-CMK=Cable Mounting Kit, Quantity 6, 1 meter long, 1/16" diameter, with spring clips & adjustable, locking ceiling attachment
PPNL1X4-40W-5K	40	4,600	115	5K= 5000k	

215-512-8100 • Fax 267-288-5604
421 Bustleton Pike, Feasterville, PA 19053
www.proliteled.com

Specifications subject to change without prior notice.
© 2016, PROlite LED Lighting, Inc. ALL RIGHTS RESERVED

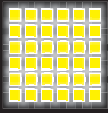

ELECTRICAL DATA

MODEL	COLOR TEMP	CRI ¹	LUMINAIRE LUMENS	LUMINAIRE WATTS	LUMENS/WATT	INPUT VOLTAGE	INPUT CURRENT (A)			POWER FACTOR	THD ²	L ₇₀ HOURS ³
							120V	240V	277V			
PPNL1X4-40W-3K	3000k	> 80	4,070	40	102	120-277	0.33	0.17	0.14	> 90%	< 20%	56,000
PPNL1X4-40W-35K	3500K	> 80	4,149	40	104	120-277	0.33	0.17	0.14	> 90%	< 20%	56,000
PPNL1X4-40W-4K	4000k	> 80	4,149	40	104	120-277	0.33	0.17	0.14	> 90%	< 20%	56,000
PPNL1X4-40W-5K	5000k	> 80	4,600	40	115	120-277	0.33	0.17	0.14	> 90%	< 20%	56,000

¹ Color rendering index

² Total harmonic distortion

³ L₇₀ refers to the number of hours at which lumen output declines to 70% of the initial level. L₇₀ hours are IES TM-21-11 calculated hours.

PHOTOMETRIC DATA

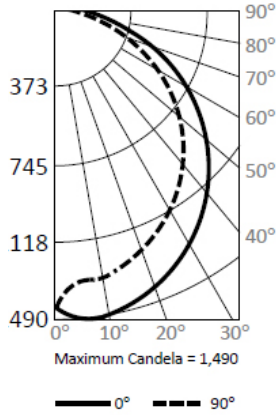

Candlepower Summary

	0°	90°
0°	1,427	1,427
10°	1,445	1,350
20°	1,343	1,296
30°	1,198	1,182
40°	1,011	1,016
50°	790	798
60°	553	563
70°	311	311
80°	96	81
90°	0	0

Zonal Lumen Summary

Zone	Lumens	% Fixture
0° – 10°	35	0.8%
0° – 20°	309	7.4%
0° – 30°	819	19.8%
0° – 40°	1,496	36.1%
0° – 50°	2,247	54.2%
0° – 60°	2,970	71.6%
0° – 70°	3,569	86.0%
0° – 80°	3,971	95.7%
0° – 90°	4,149	100.0%
90° – 180°	0	0.0%
0° – 180°	4,149	100.0%

Cone of Light

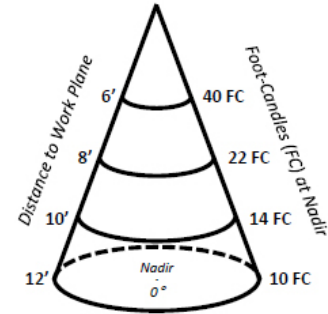

OPTIONS

- Optional surface mounting kits (LEDSMKT-14) mounts below the ceiling.
- Optional flange mounting kits provide for recessed installation on plaster or other hard ceilings. Attach Flange Mount Kit (FLANGEKIT14-ET) to ceiling joists or other stationary structures, and the panel is mounted flush to the ceiling.
- Optional cable mounting kits provide additional security, as well as suspended mounting. Attach one end of the Cable Mount Kit (LEDPNL-CMK) to luminaire earthquake clips using spring clips, and attach the other end to stationary structures using the adjustable, locking ceiling attachment (see picture below right).

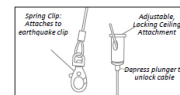
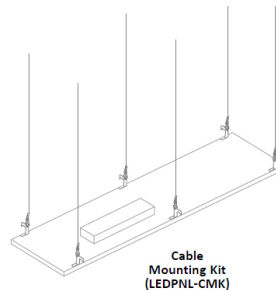
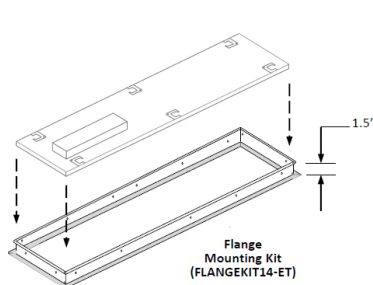
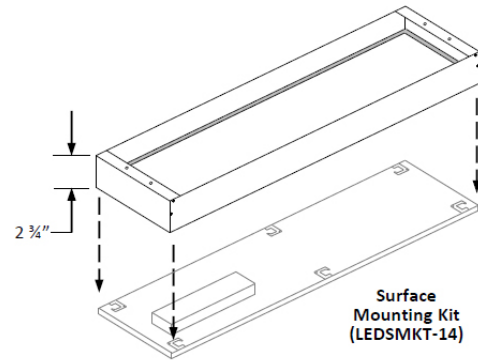

- Cable Mount Kit:
- Spring Clip
 - Adjustable, locking ceiling attachment